



## VERONIQUE AGI V16

March 12 1959  
Emission of a sodium  
cloud at 120 km altitude.  
France enters  
the space age

1/48th scale model  
19 cm high  
100% FDM printer

Include resin part  
for launch pad  
And decal.



CHRONIC3D.COM



FDM version

Resin version

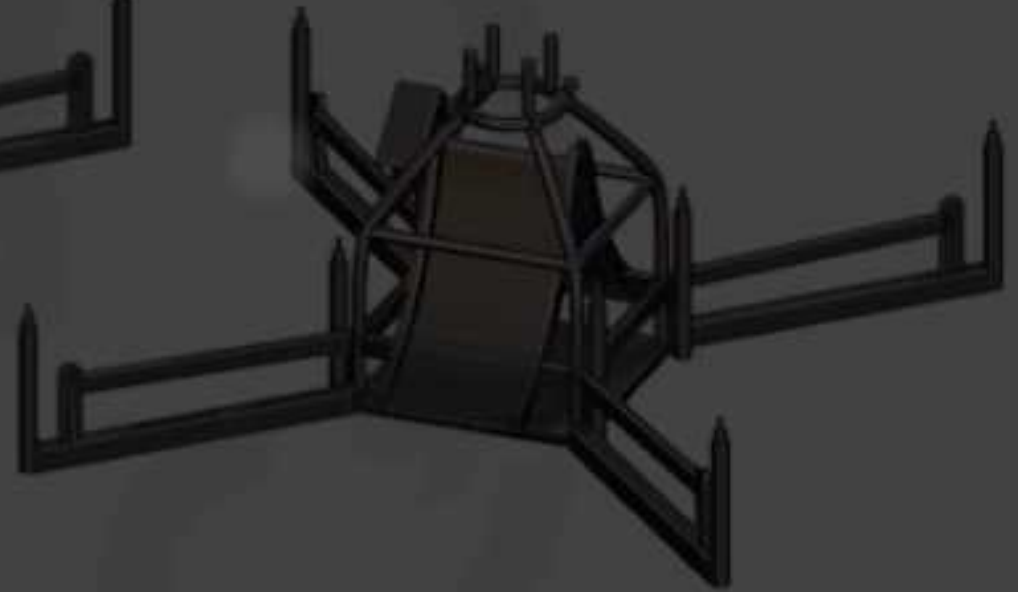

Choose your launch pad : FDM or Resin version

the following assembly instructions show the FDM version

Purple : gluing area

Black 01

Grey 01

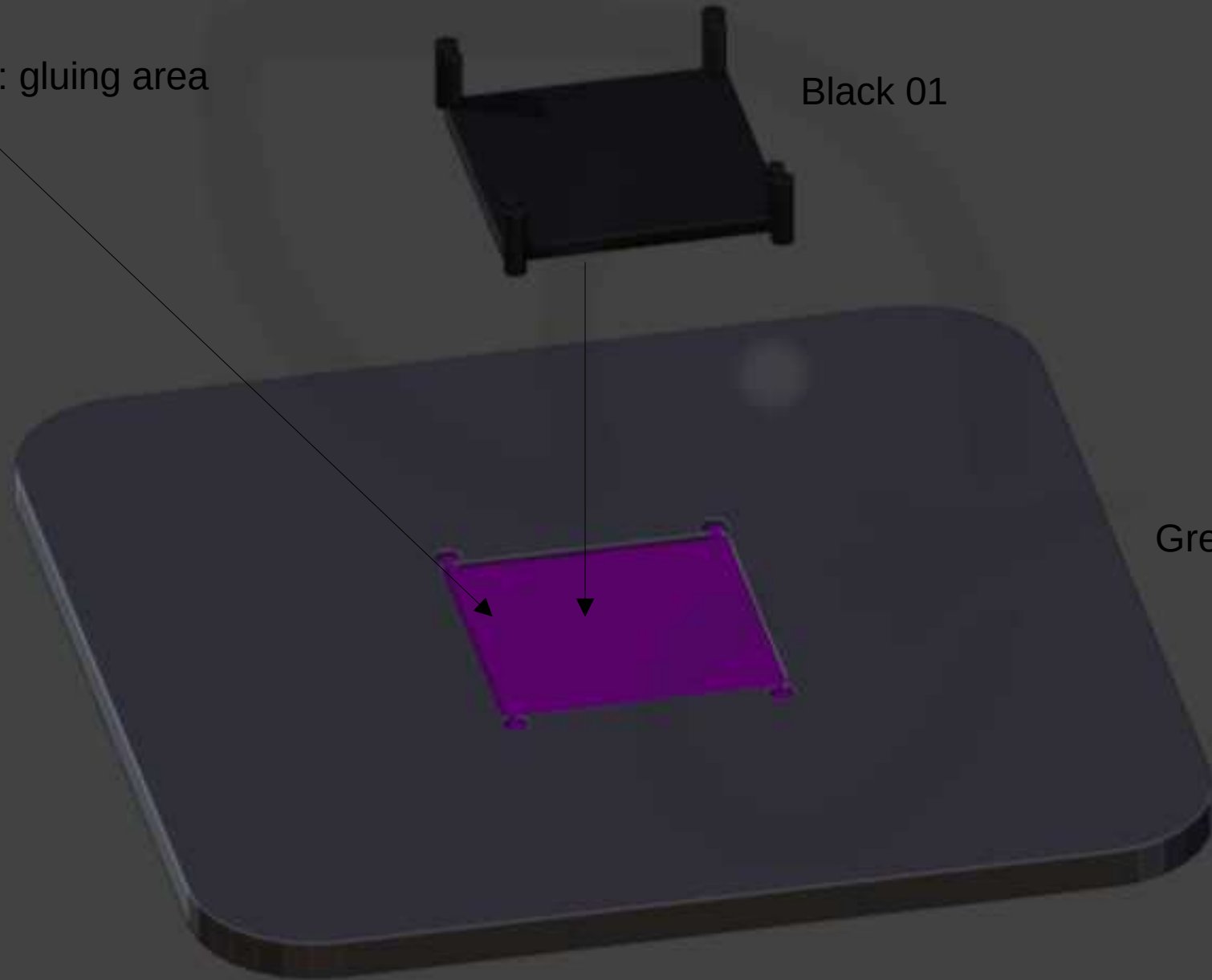

Black 02 x2

black 03 x2

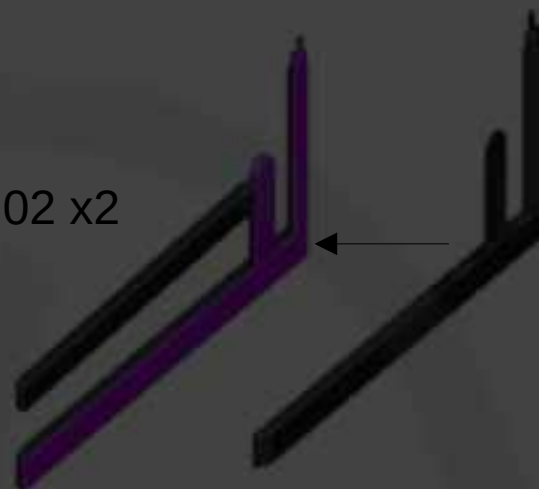

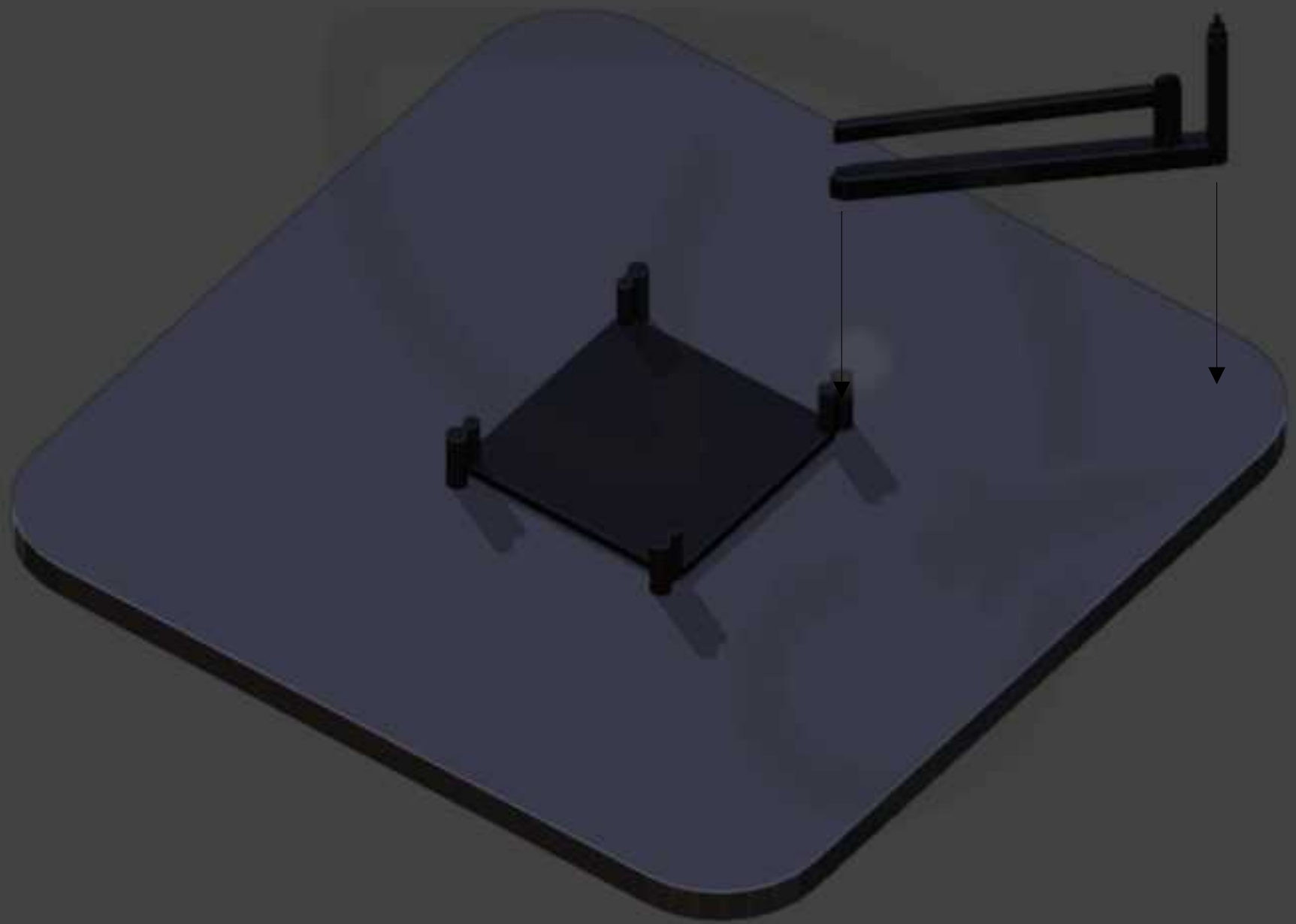

Check orientation

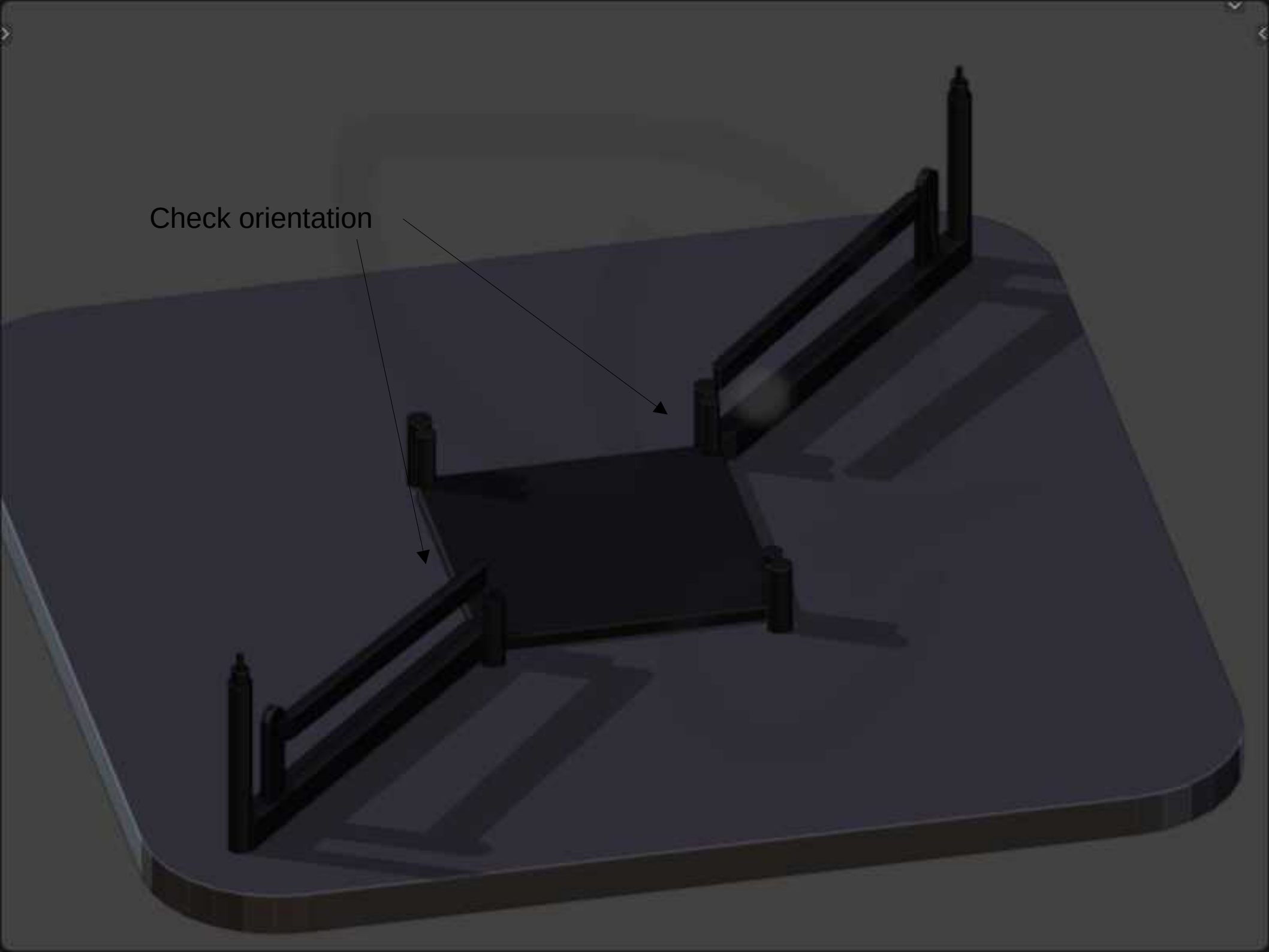

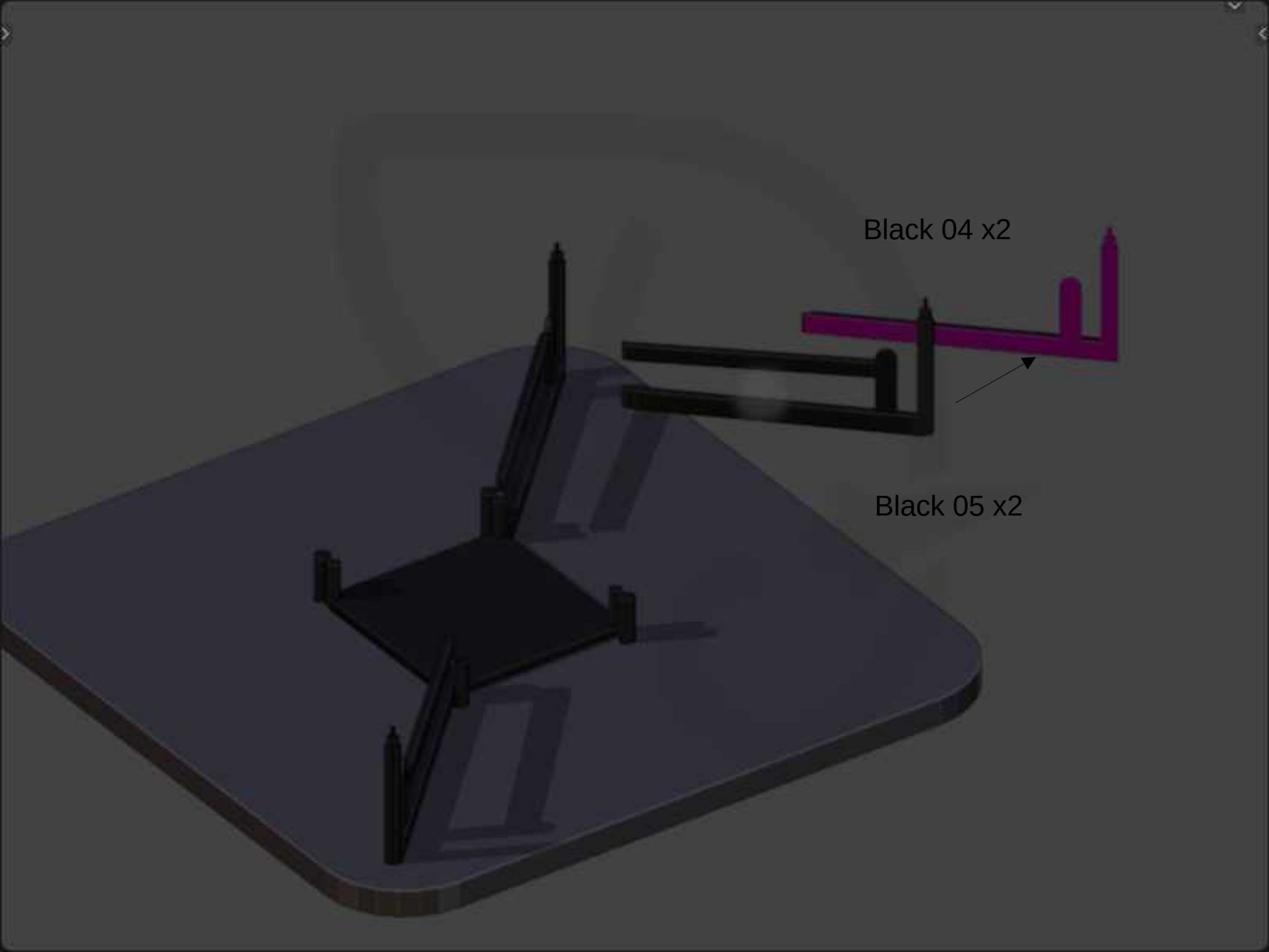

Black 04 x2

Black 05 x2

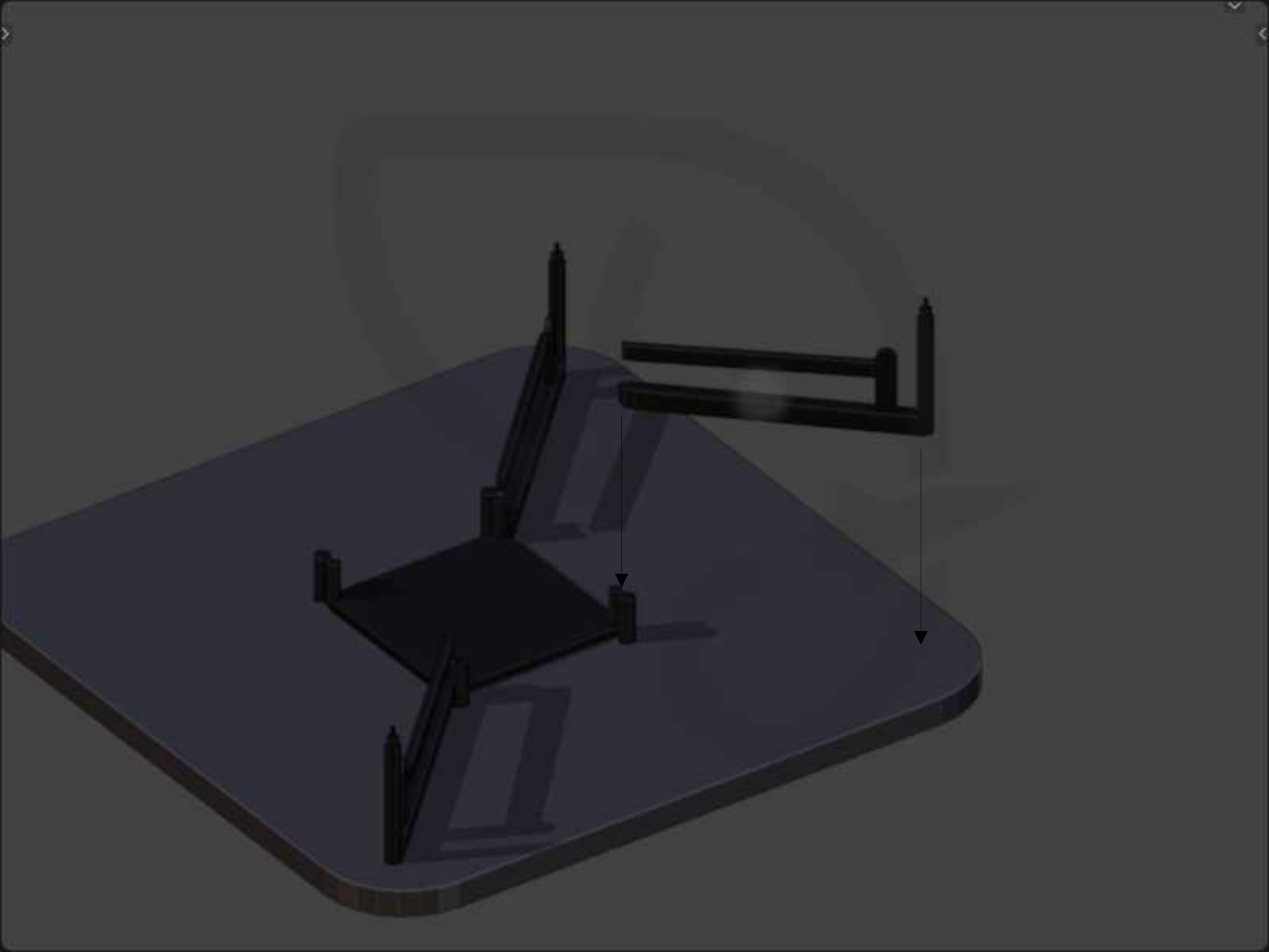



Check orientation

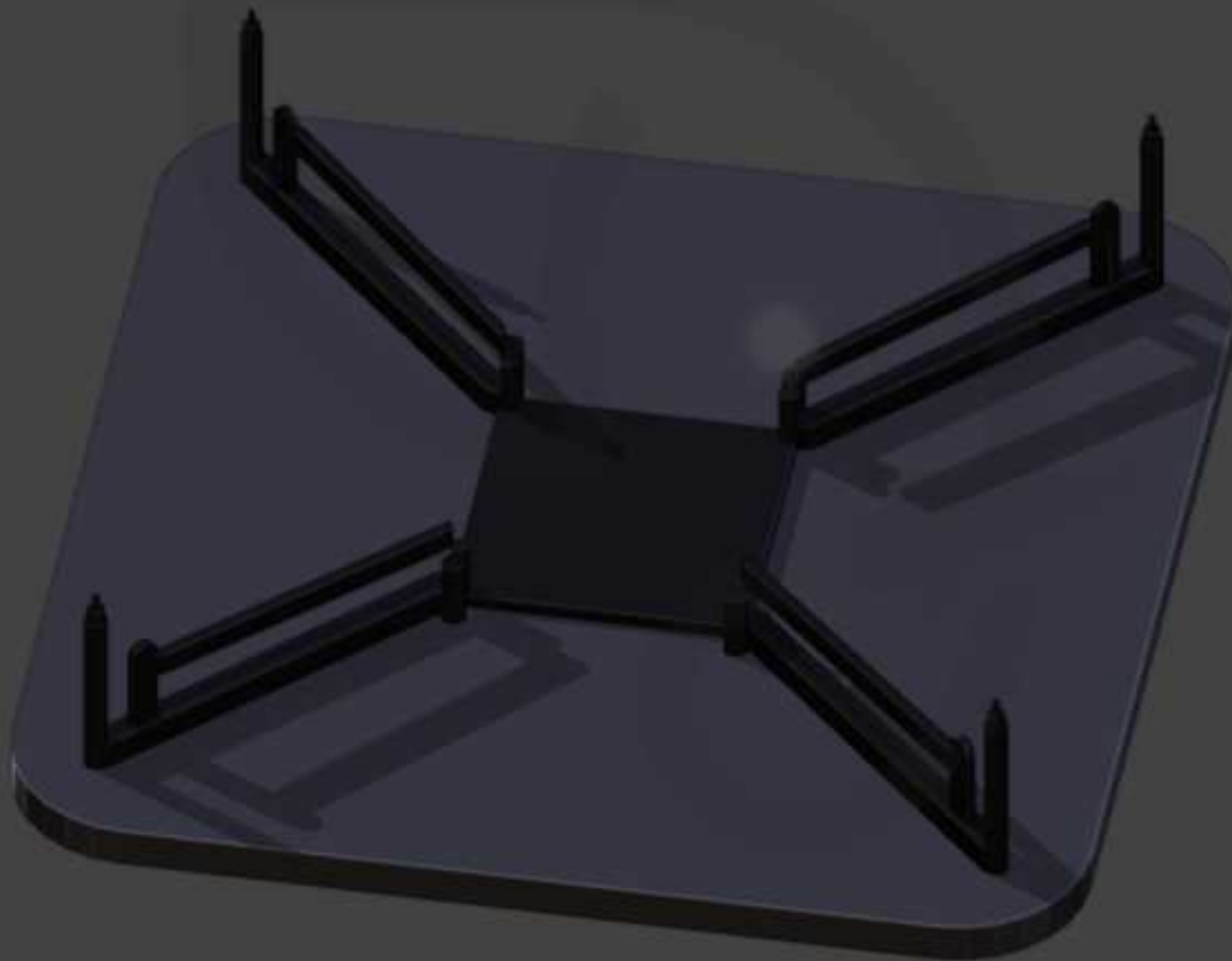

Black 06 x2

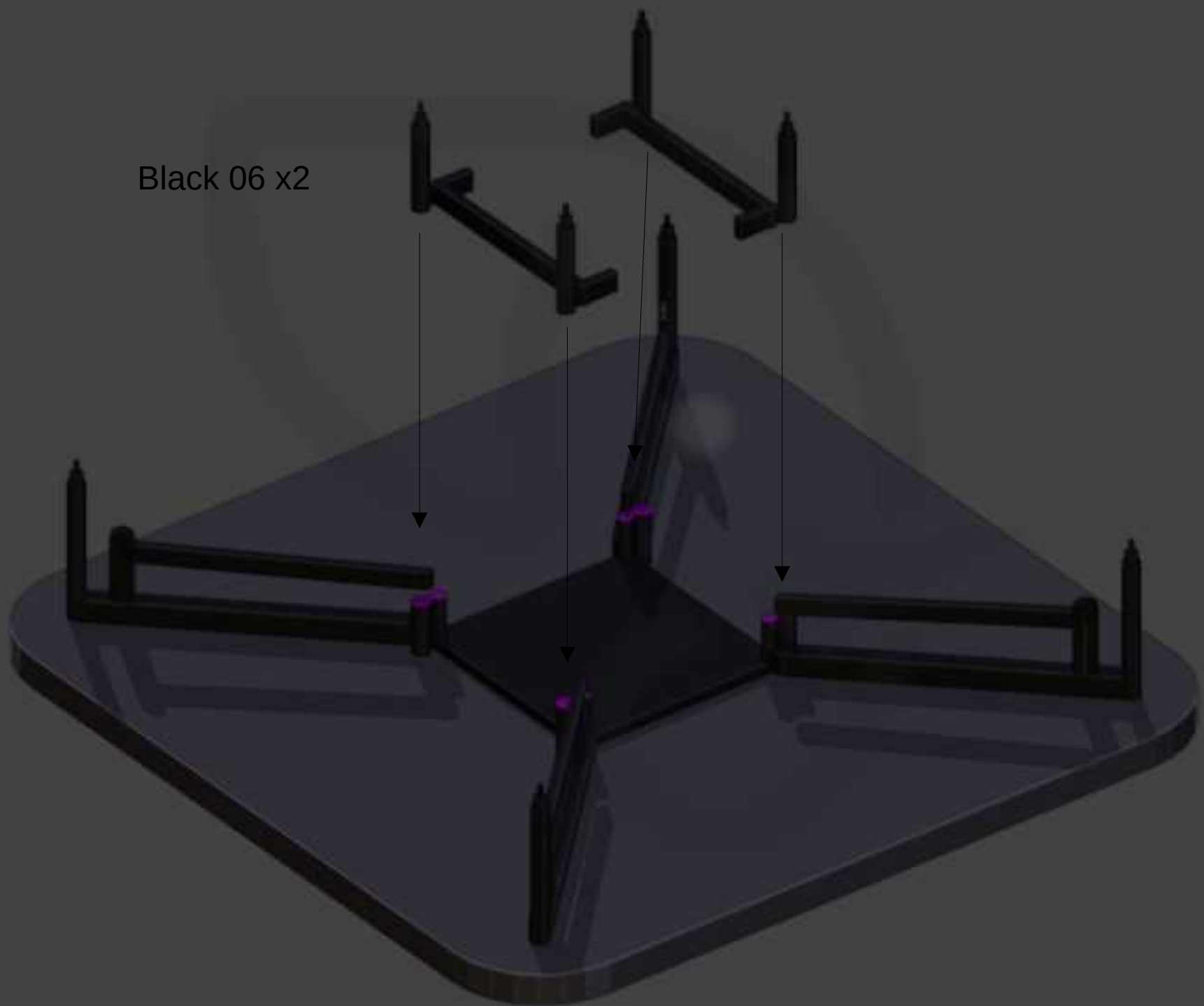



Black 07 x2



Blue : support to remove



Black 08 x2





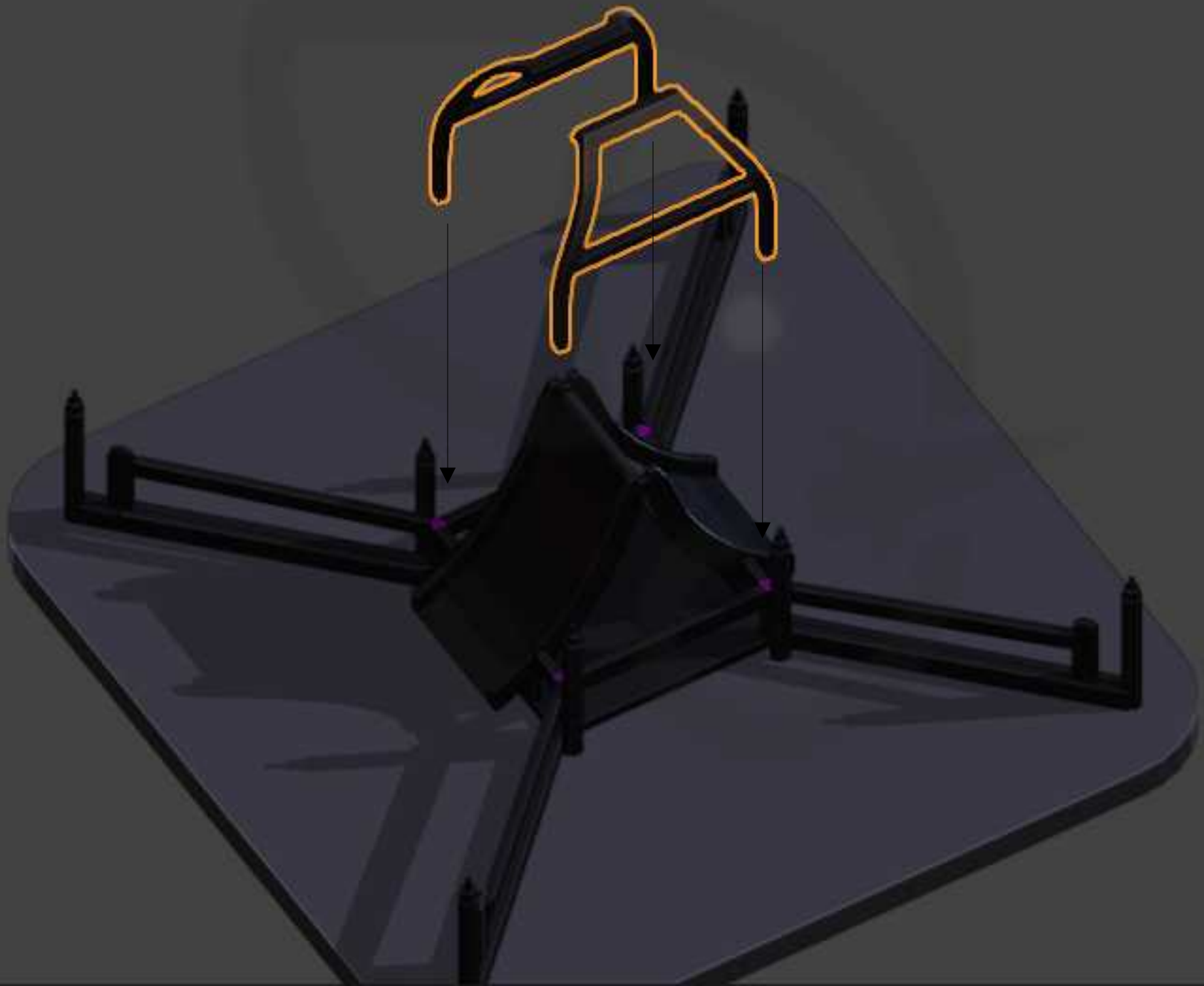

Black 09

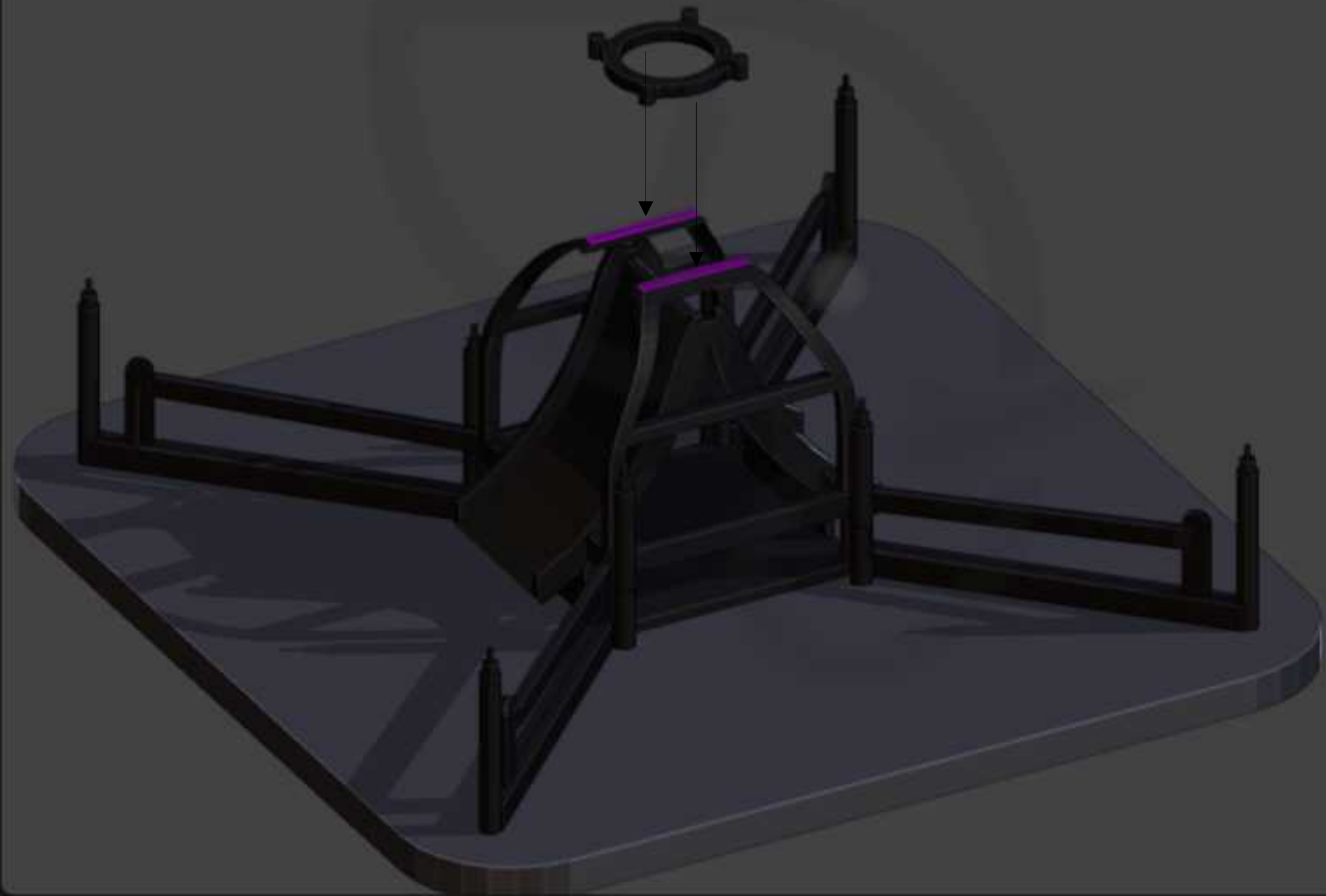



Silver 01



Black 10







White 01 x4

white 02 x4



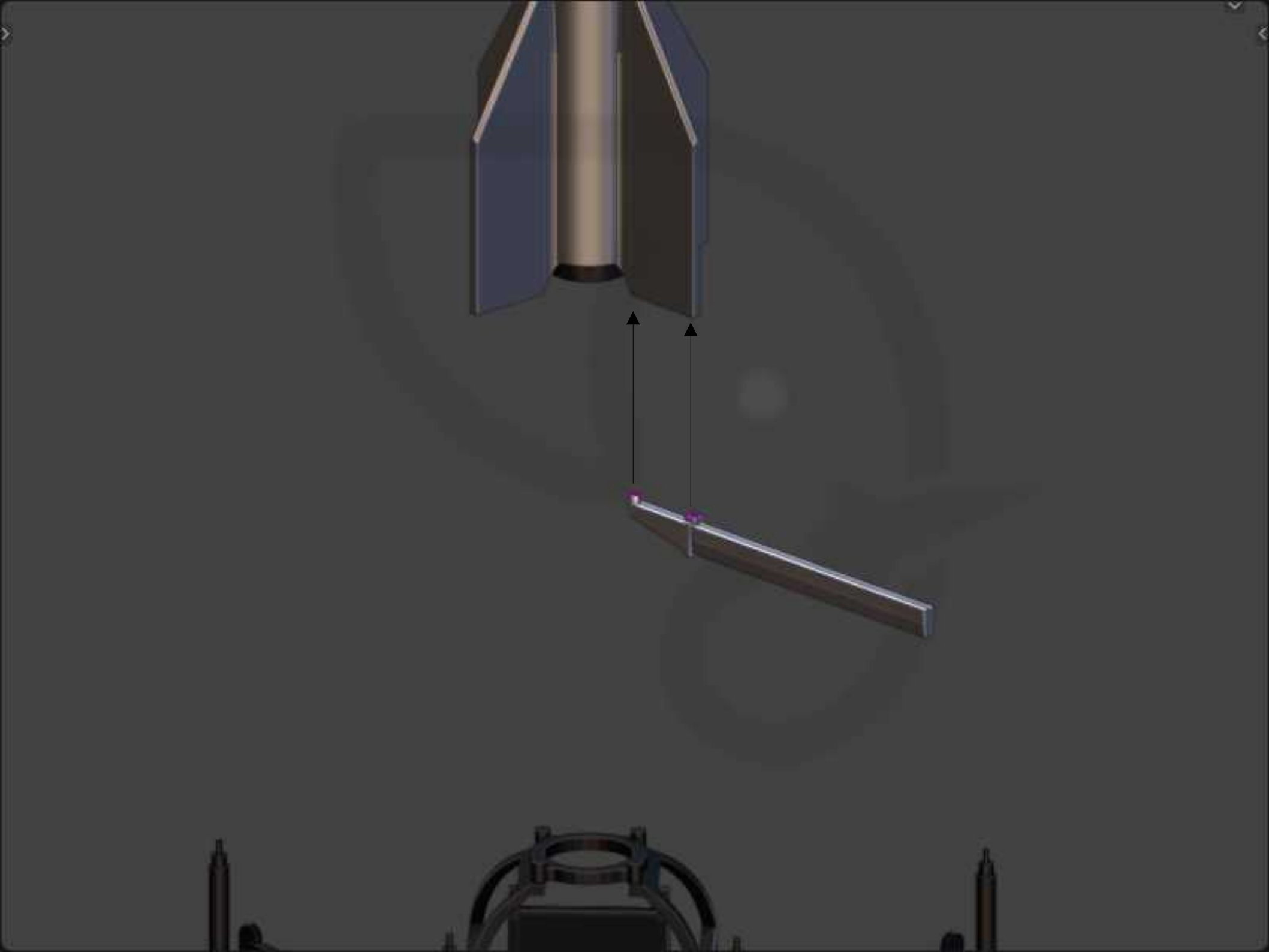

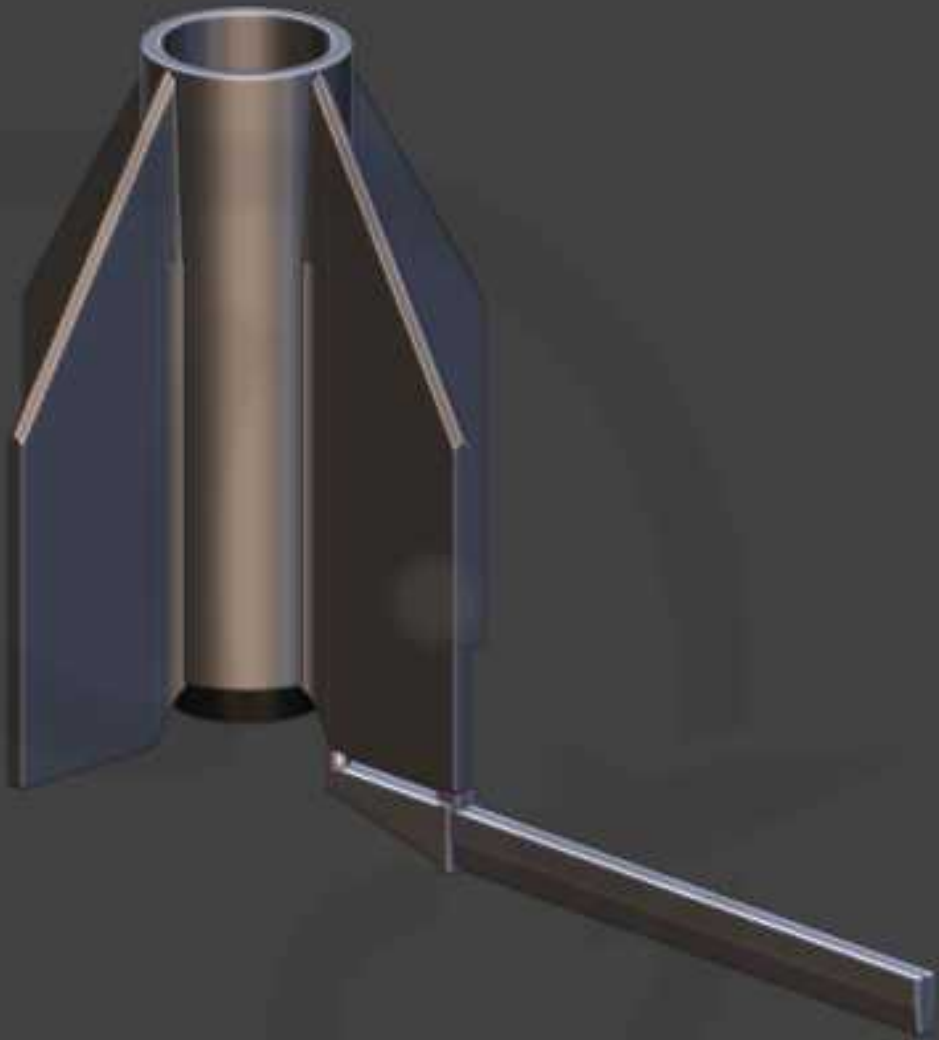

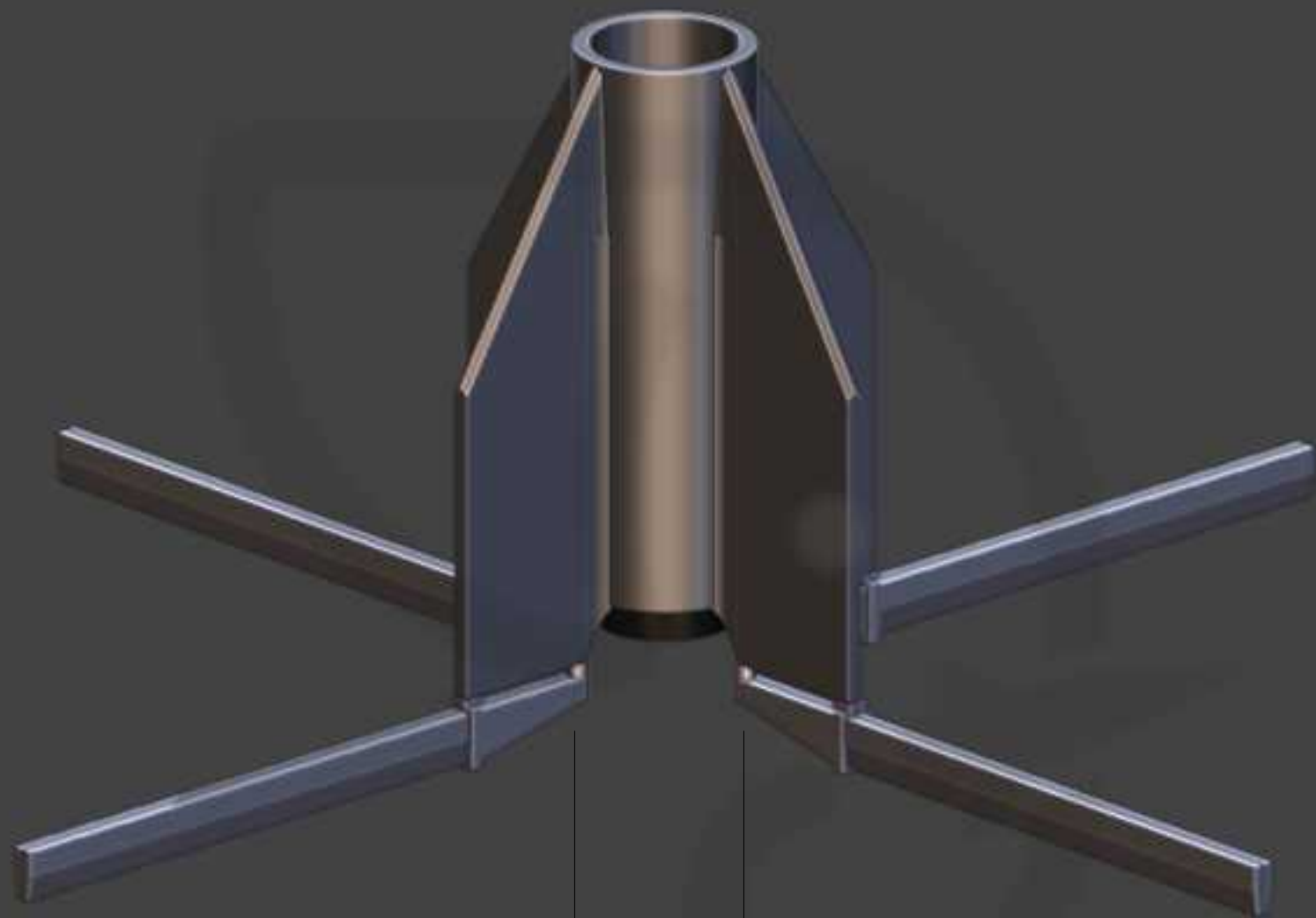

glue four retaining wires

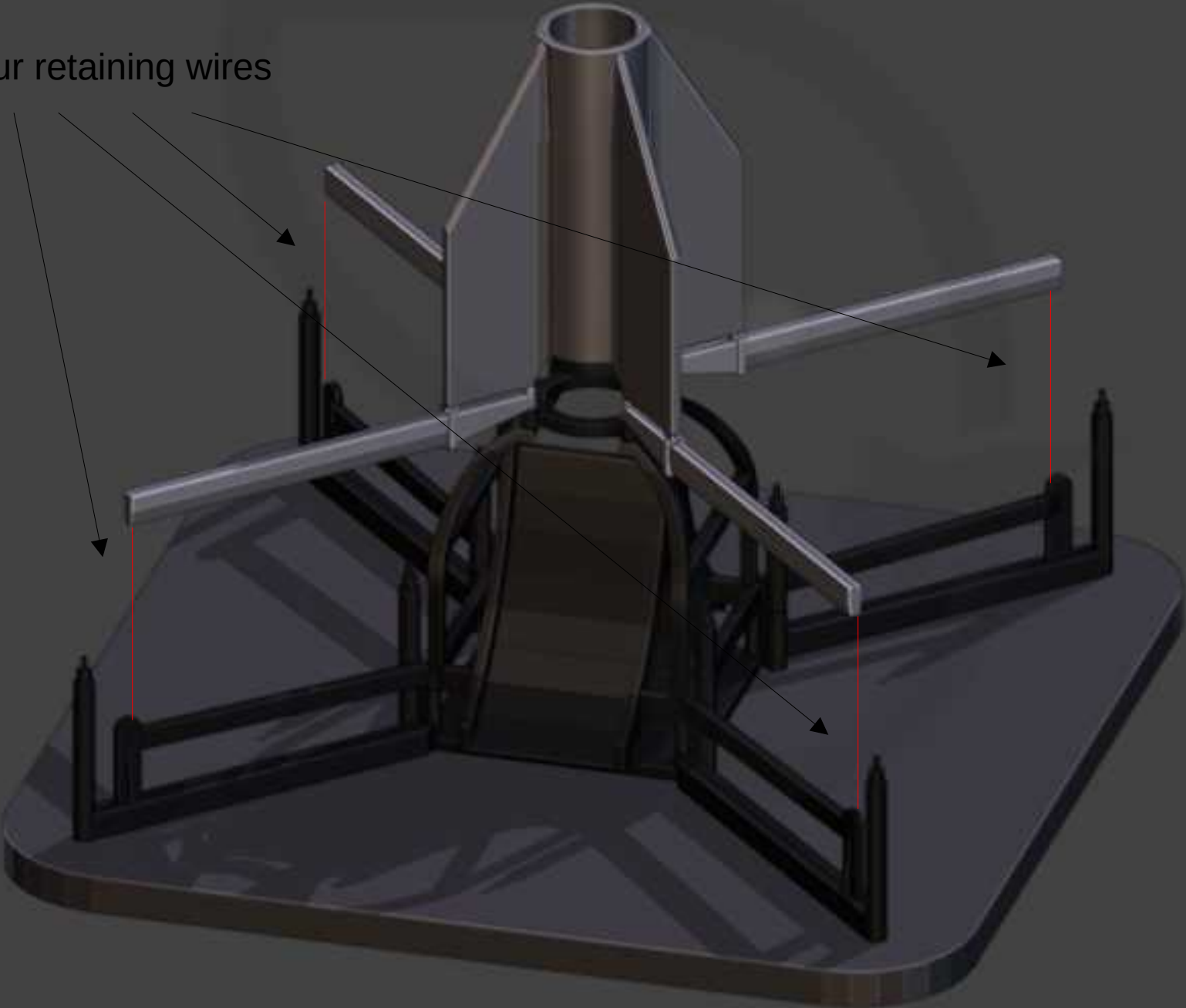



Black 11

Silver 02



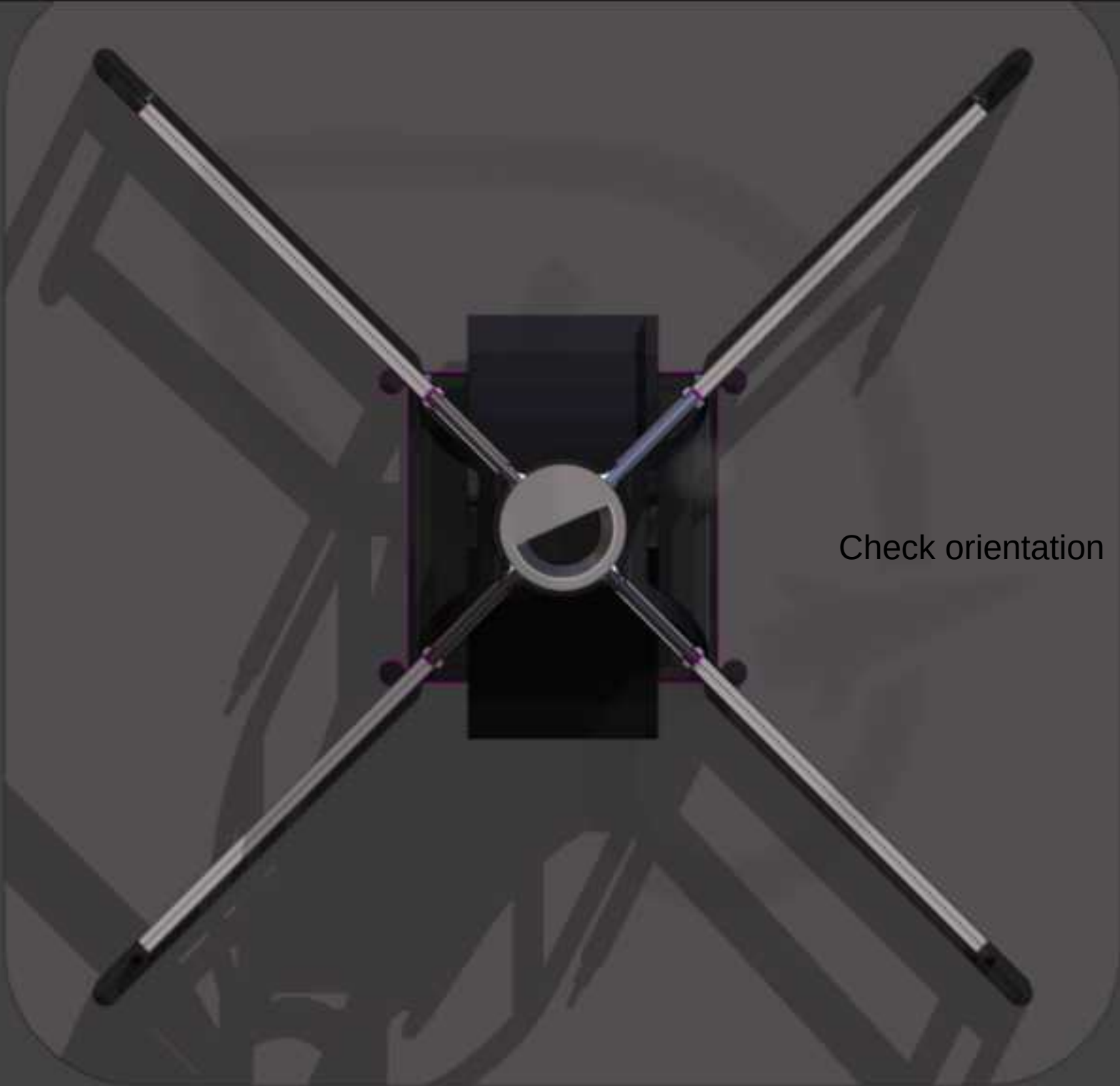

Check orientation





Silver 03 x2



White 03



Silver 04

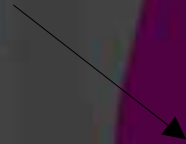



White 04



WELL DONE !



The V16 decal is placed here,  
on the white part